

## **Trouble finding the right spare part? Let us help!**

### **Appliances**

For most appliances, typically just the make and model along with component required is all we need to identify the right part.

Eg; Fan forced element to suit a Blanco BOSE635X Oven.

### **Hot Water Systems**

For Hot Water Elements, the type of mounting plate, immersion length, wattage and sickle or off-set is important. We can identify a suitable replacement from this detail.

### **Unknown model or custom elements**

When brand is known but the model is not, we may be able to identify from markings on the item. A photo(s) of the part, with dimensions and any other relevant detail such as the wattage or voltage will be useful to assist with your enquiry.

**Send the details to**  
[sales@stokesap.com.au](mailto:sales@stokesap.com.au)

**Or call our sales team**  
**1800 333 191**

(Freight \$15 exGST. Orders over \$150 exGST are FIS.)

# Stokes

## Appliance Parts

Domestic Commercial Industrial

### BOLT-ON HOT WATER ELEMENTS



#### SICKLE ELEMENTS

CODE	COPPER	LENGTH
3662S	1800W	257
2855H	2400W	295
3665S	3600W	252
3666S	4800W	322

CODE	INCOLOY 800	LENGTH
1329XSN	2400W	300
1330XSN	3000W	255
1331XSN	3600W	255
1321XSN	4800W	325

CODE	INCOLOY 825	LENGTH
3482XSN	3600W	255
3480XSN	4800W	325



#### OFFSET ELEMENTS

CODE	INCOLOY 800	LENGTH
1337XN	1500W	280
1327XN	1800W	190
1329XN	2400W	240
1330XN	3000W	260
1331XN	3600W	330
1321XN	4800W	420
4912	6000W	460

CODE	INCOLOY 825	LENGTH
3480XN	4800W	420

CODE	INCOLOY 825 SPECIAL	LENGTH
4944	3600W LOW DENSITY	440
4945	4800W LOW DENSITY	600
4946	6000W LOW DENSITY	700

LENGTH QUOTED IS THE IMMERSION LENGTH IN MM (+/-5)

COPPER NOT SUITABLE FOR HARD WATER CONDITIONS

Contact us for more information.

**Sales: 1800 333 191**

**sales@stokesap.com.au**

Stokes Appliances Pty Ltd Unit 2, 170 Rooks Road, Nunawading VIC 3131 PO Box 168 Mitcham Victoria 3132

T +61 3 9872 7474 F +61 3 9872 7444 www.stokesap.com.au

## Quality Australian Made Hot Water 'Bobbin' Elements



B6A	1&5/8 INCH HOT WATER ELEMENT 1500W (42x320mm)
B5A	1&5/8 INCH HOT WATER ELEMENT 1800W (42x370mm)
B4A	1&5/8 INCH HOT WATER ELEMENT 2750W (42x500mm)
B3A	1&5/8 INCH HOT WATER ELEMENT 2400W (42x470mm)
B2A	1&5/8 INCH HOT WATER ELEMENT 2750W (42x350mm)
B1A	1&5/8 INCH HOT WATER ELEMENT 3300W (42x500mm)
B7	2 INCH HOT WATER ELEMENT 1200W (50x220mm)
B6	2 INCH HOT WATER ELEMENT 1500W (50x320mm)
B4	2 INCH HOT WATER ELEMENT 2000W (50x370mm)
B3	2 INCH HOT WATER ELEMENT 2400W (50x370mm)
B2	2 INCH HOT WATER ELEMENT 3000W (50x500mm)
B1	2 INCH HOT WATER ELEMENT 3600W (50x500mm)
9186	340MM COPPER SHEATH
9187	382MM COPPER SHEATH
9188	535MM COPPER SHEATH

(The details above located in Section F of Stokes Service Manual)

**Sales: 1800 333 191**

# Stokes

## Appliance Parts

Domestic Commercial Industrial

### 30x22mm Illuminated Rocker Switches

Double Pole (2NO) | Rating: 250V, 16A | Connection: Faston 6.3mm | IP65 if cover added



GEV301001 Red    GEV301002 Amber    GEV301003 Green    GEV301009 White    GEV301036 IP65 Cover    Terminal Layout

### 30x11mm Illuminated Rocker Switches

Single Pole (1NO/1NC) | Rating: 250V, 16A | Connection: Faston 6.3mm | IP65 if cover added

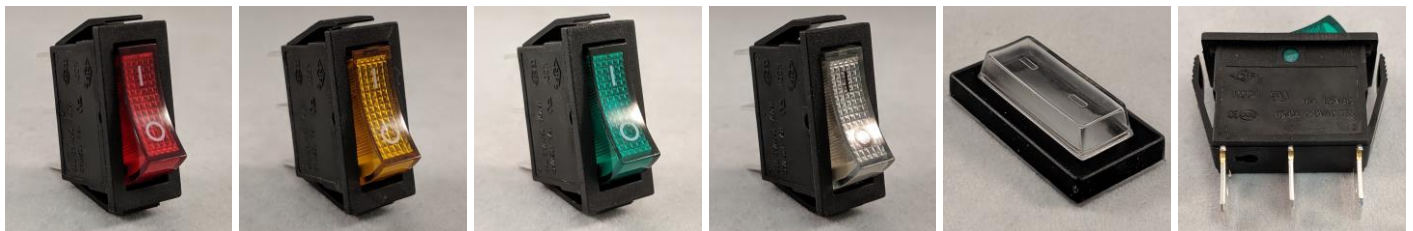

GEV301010 Red    GEV301011 Amber    GEV301012 Green    GEV301053 White    GEV301035 IP65 Cover    Terminal Layout

### 30x22mm Various Switches

Double Pole (2NO) | Rating: 250V | Connection: Faston 6.3mm



WOD030 12A Woodson On/Off Push Switch    GEV347974 20A Red Illuminated Rocker with rubber Collar (IP65)    GEV301202 20A IP65 Black Rocker with rubber collar (IP65)    Terminal Layout

E-mail: [sales@stokesap.com.au](mailto:sales@stokesap.com.au)

Sales: 1800 333 191

Stokes Appliances Pty Ltd Unit 2, 170 Rooks Road, Nunawading VIC 3131 PO Box 168 Mitcham Victoria 3132

T +61 3 9872 7474 F +61 3 9872 7444 [www.stokesap.com.au](http://www.stokesap.com.au)

# Stokes

## Appliance Parts

Domestic Commercial Industrial

### Toggle & Rocker Switches



7021C



AH6006



T5-21



A14



S6SGREEN



A69

7011C	TOGGLE SPST (20A) 250V On-Off	A8	TOGGLE SPST SERIES 475 Black (10A)
7021C	TOGGLE DPST (20A) 250V On-Off	AH6006	PANTRY SWITCH SPST (10A)
A13	ROCKER DPST SERIES 50 (15A)	ERM095	ROCKER WHITE ROUNDED CORNERS (16A)
A14	ILLUM ROCKER RED DPDT SERIES 50 (15A)	S1	ILLUM ROCKER RED DPDT SERIES 82 (12A)
A2	ROCKER SPDT SERIES 40 MOMENTARY (15A)	S4	ILLUM ROCKER RED DPDT 82 SERIES (12A)
A4	ROCKER SPST SERIES 40- BLACK (15A)	S6	ILLUM ROCKER RED DPST SERIES 50 (15A)
A52	ROCKER SPST SERIES 39 BLACK (10A)	S6SG	DPST RED ILLUM ROCKER SPLASH GUARD (15A)
A6	ROCKER RED SPST-URNS (15A)	T5-11	TOGGLE SWITCH (15A) 240VOLT SPST 'On-Off'
A69	PUSH BUTTON FRIDGE SPST SERIES 61 (0.25A)	T5-21	TOGGLE SWITCH (15A) 240VOLT DPST 'On-Off'

(\*stated Amp ratings 'AC-1')

Plus many more! See 'Section H' of the Stokes Service Manual or contact us for more information.

**Sales: 1800 333 191**

# Stokes

## Appliance Parts

Domestic Commercial Industrial

### Infrared Quartz Lamps

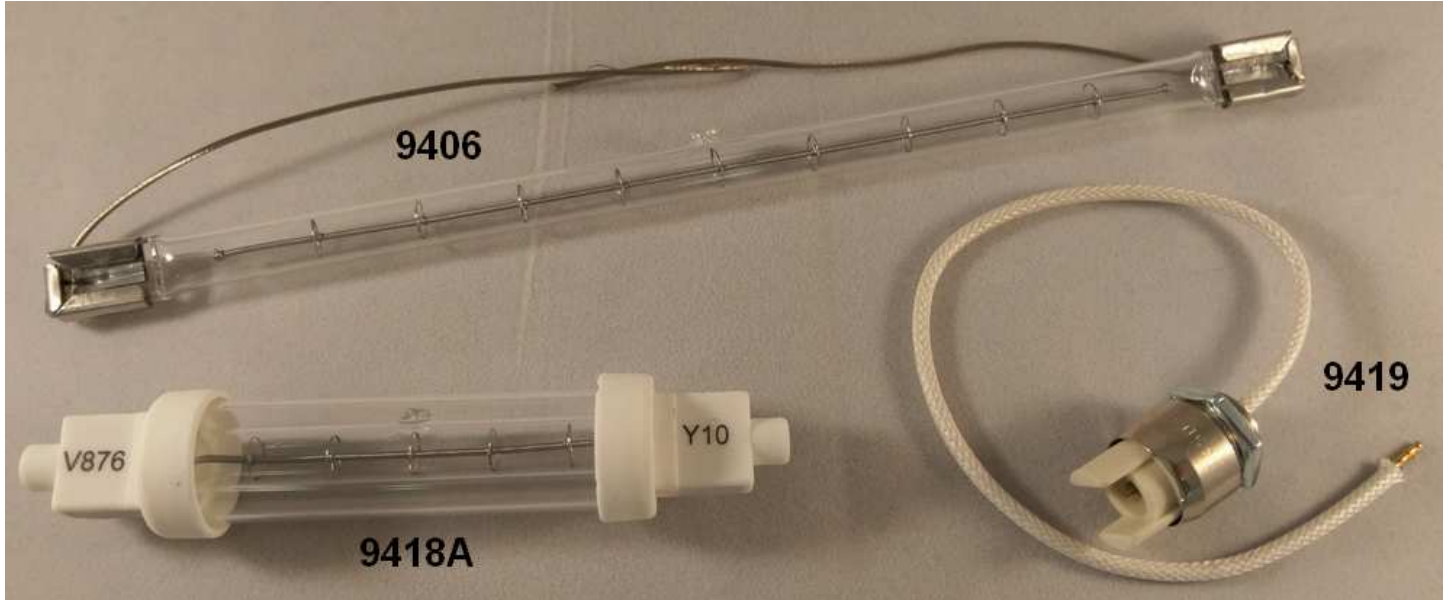

CODE	DESCRIPTION	LENGTH
9403	INFRARED QUARTZ LAMP 500W 120V CERAMIC ENDS WITH LEADS	235mm
9404	INFRARED QUARTZ LAMP 500W 120V METAL ENDS WITH LEADS	230mm
9405	INFRARED QUARTZ LAMP 500W 240V CERAMIC ENDS WITH LEADS	235mm
9406	INFRARED QUARTZ LAMP 500W 240V METAL ENDS WITH LEADS	225mm
9407	INFRARED QUARTZ LAMP 1000W 240V CERAMIC ENDS WITH LEADS	344mm
9408	INFRARED QUARTZ LAMP 1000W 240V METAL ENDS WITH LEADS	350mm
9413	INFRARED QUARTZ LAMP 500W 240V CERAMIC ENDS NO LEADS	220mm
9414	INFRARED QUARTZ LAMP 1600W 240V CERAMIC ENDS WITH LEADS	495mm
9415	INFRARED QUARTZ LAMP 500W 240V CERAMIC ENDS NO LEADS	232mm
9415A	INFRARED QUARTZ LAMP 300W 240V CERAMIC ENDS WITH LEADS	234mm
9417	INFRARED QUARTZ LAMP 500W 240V CERAMIC ENDS NO LEADS	220mm
9417A	INFRARED QUARTZ LAMP DOUBLE JACKET 300W 240V CERAMIC ENDS NO LEADS	220mm
9418	INFRARED QUARTZ LAMP DOUBLE JACKET 200W 240V CERAMIC ENDS NO LEADS	120mm
9418A	INFRARED QUARTZ LAMP DOUBLE JACKET 300W 240V CERAMIC ENDS NO LEADS	118mm
9422	INFRARED QUARTZ LAMP DOUBLE JACKET 1500W 240V CERAMIC ENDS WITH LEADS	440mm
9426	INFRARED QUARTZ LAMP 500W 240V METAL TAGS	300mm
9416	LAMP HOLDER CERAMIC ENDS QUARTZ LAMP PKT	
9419	QUARTZ LAMP HOLDER WITH NUT	

Plus many many more! Contact us for more information.

**Sales: 1800 333 191**

Stokes Appliances Pty Ltd Unit 2, 170 Rooks Road, Nunawading VIC 3131 PO Box 168 Mitcham Victoria 3132  
 T +61 3 9872 7474 F +61 3 9872 7444 www.stokesap.com.au

# Stokes

## Appliance Parts

Domestic Commercial Industrial

## F/F OVEN ELEMENTS & MOTORS



CODE	RATING	FAN FORCED ELEMENTS TO SUIT BRANDS	STYLE
1976	2400W	CHEF (EARLY MODELS)	DOUBLE RING
10252	2400W	ILVE, BLANCO, TECHNIKA, ROSIERE, PACIFIC GORENJE	DOUBLE RING
10318	2200W	LATER MODELS, WESTINGHOUSE, CHEF & SIMPSON	DOUBLE RING
ERM170	2200W	ELECTROLUX, WESTINGHOUSE	DOUBLE RING
10758	2200W	SMEG, OMEGA & OTHERS	DOUBLE RING (WITH BOLTS)
9666	2500W	BLANCO, GLEM, ARISTON, MIELE, LINEA, WHIRLPOOL, BAUMATIC, ZANUSSI & MORE	TRIPLE RING
203174	2400W	SMEG, BLANCO, AEG, OMEGA, LA GERMANIA	DOUBLE RING
KM77X2277	2000W	KLEENMAID, BLANCO	DOUBLE RING (WITH BOLTS)
FP447752	2500W	FISHER & PAYKEL, NEFF	DOUBLE RING
2546	2200W	ST GEORGE	DOUBLE RING
ME12570030	2300W	OMEGA, DAMANI, KLEENMAID, ST GEORGE	TRIPLE RING

CODE	FAN FORCED OVEN MOTORS TO SUIT BRANDS
9683	FF OVEN MOTOR FAN KIT (UNIVERSAL, SUITS MANY BRANDS)
S50862	FF OVEN MOTOR FAN & BLADE LONG SHAFT (ST GEORGE)
50922	FF OVEN MOTOR FAN & BLADE SHORT SHAFT (ST GEORGE, KLEENMAID)
10711	FF OVEN MOTOR FAN KIT (SMEG, PIE WARMERS)
ERM666	TWIST MOUNT FF OVEN MOTOR (CHEF)
10777	TWIST MOUNT FF OVEN MOTOR (SMEG, OMEGA)

Many more in stock. Contact us for more information.

**Sales: 1800 333 191**  
**sales@stokesap.com.au**

# Stokes

## Appliance Parts

Domestic Commercial Industrial

# INFRARED HEATERS FOR COMMERCIAL & INDUSTRIAL APPLICATIONS



STOCK CODE	RATING	OVERALL LENGTH	REPLACEMENT ELEMENT
RU08	800W 3.3A	600mm	KQ77A000
RU11	1100W 4.6A	740mm	KQ77B000
RU15	1500W 6.25A	930mm	KQ77C000
RU18	1800W 7.5A	1070mm	KQ77D000
RU24	2400W 10A	1365mm	KQ77E000
RU30	3000W 12.5A	1635mm	KR43A000
RU36	3600W 15A	1900mm	KR43B000

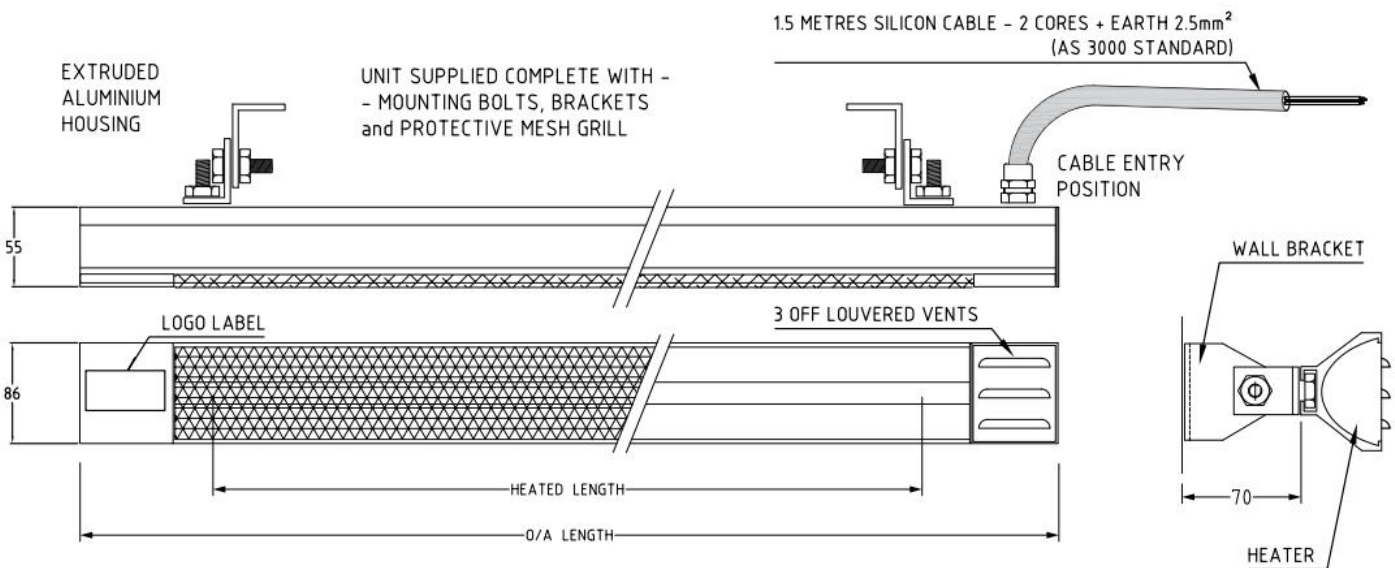

Replacement elements available.  
Installation by a licensed electrician only.

Contact us for more information.

Sales: 1800 333 191  
sales@stokesap.com.au



# Stokes

## Appliance Parts

Domestic Commercial Industrial

# THERMOSTATS AND CONTROLS

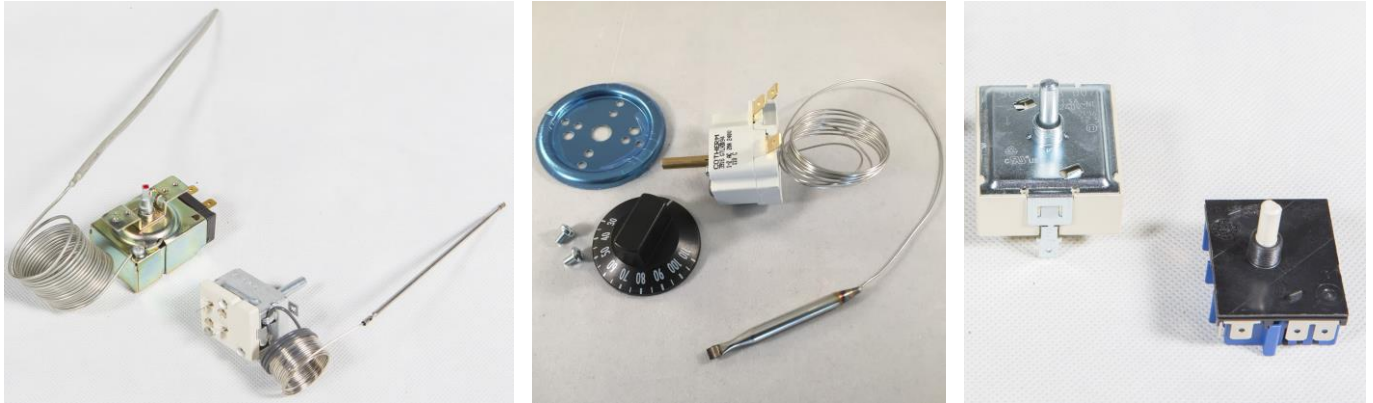





CODE	DESCRIPTION	CAPILLARY	TO SUIT
9780	OVEN THERMOSTAT 50-320C 16AMP	1470mm	VARIOUS
7410-E	OVEN THERMOSTAT 50-320C 16AMP	1470mm	VARIOUS
U-7400-A	THERMOSTAT KIT 30-110C 20AMP	1430mm	COMMERCIAL
EA3-447-08	OVEN THERMOSTAT 70-290C 30AMP	2250mm	VARIOUS
EFG-201	OVEN THERMOSTAT 50-300C 16AMP	1400mm	VARIOUS
55.17042.050	DEEP FAT FRYER THERMOSTAT 98-205 C	840mm	COMMERCIAL
55.19059.810	TWIN BULB OVEN THERMOSTAT 55-280 C	1350mm	EUROPEAN MODELS
10706	OVEN THERMOSTAT 50-265C	950mm	SMEG, BOSCH
7406-E	THERMOSTAT 30-110C 16 AMP	1460mm	COMMERCIAL
EA5-701-4	THERMOSTAT 95-205C 25AMP SPST	1220mm	VARIOUS
EA5-607-0	THERMOSTAT 15-120C 20AMP	1830mm	COMMERCIAL







CODE	DESCRIPTION	TO SUIT
TYJ6303	SIMMERSTAT CONTROL SUNVIC	URNS, STEAMERS, BAIN MARIES
MP-101	ENERGY REGULATOR 15AMP	WESTINGHOUSE, SIMPSON, ELECTROLUX, CHEF
M553-14	INFINITE CONTROL 15AMP	WESTINGHOUSE, SIMPSON, ELECTROLUX, CHEF
M823-14	INFINITE CONTROL DIVIDED 15AMP	WESTINGHOUSE, SIMPSON, ELECTROLUX, CHEF
7405	INFINITE CONTROL 13AMP	ROBAND, WOODSON, STODDART, MOFFAT
10553	ENERGY REGULATOR SINGLE POLE 13A	ROBAND, WOODSON, STODDART, MOFFAT

**Many more in stock. We also carry a large range of thermostats and over temp controls to suit other appliances such as fridges and freezers. Contact us for more information.**

**Sales: 1800 333 191**

**[sales@stokesap.com.au](mailto:sales@stokesap.com.au)**

PROGRAMMABLE	TH9320	GCT611	GCT711	CMT907
				
Wi-Fi	✓			
240Vac			✓	✓
24Vac	✓	✓		✓
Heat only	✓	✓	✓	✓
Cool only	✓	✓		✓
Heating & Cooling	✓	✓		
Number of Stages	3H/2C	1H/1C	1H	1H or 1C
Heatpump	✓	✓		
Electric heating			✓	✓
FAN	✓	✓		
Heat pump w/auxiliary heat	✓			
Backlit display	HD Colour	✓	✓	✓
Programmable periods per day	4	4	4	6
Touch screen	✓			
Remote Sensor (optional)			✓	✓
Frost Protection				✓
Current Rating - Resistive (Inductive)	1	0.02-1	16.7	0.5-8 (0.5-3)

NON-PROGRAMMABLE	GCT522	GCT511	GCT66	T4060B	T6360D	T6060B	ST6376B
							
240Vac			✓	✓	✓	✓	✓
24Vac	✓	✓	✓				
Heat only	✓	✓	✓	✓			
Cool only	✓	✓	✓		✓		
Heating & Cooling	✓	✓				✓	✓
Number of Stages	2H/2C	1H/1C	1H or 1C	1H	1C	1H/1C	1H/1C
Heatpump	✓	✓				✓	✓
Electric			✓	✓	✓		
Fan	✓	✓					✓
Heat pump w/auxiliary heat	✓						
Digital	✓	✓	✓				
Dial				✓	✓	✓	✓
Frost Protection			✓				
Current Rating - Resistive (Inductive)	0.02-1	0.02-1	0.01-8 (0.1-3)	16	10	10	4

Contact us for more information.

**Sales: 1800 333 191      sales@stokesap.com.au**

Stokes Appliances Pty Ltd Unit 2, 170 Rooks Road, Nunawading VIC 3131 PO Box 168 Mitcham Victoria 3132

T +61 3 9872 7474 F +61 3 9872 7444 www.stokesap.com.au

# Stokes

## Appliance Parts

Domestic Commercial Industrial

# GENUINE ROBERTSHAW HOT WATER THERMOSTATS

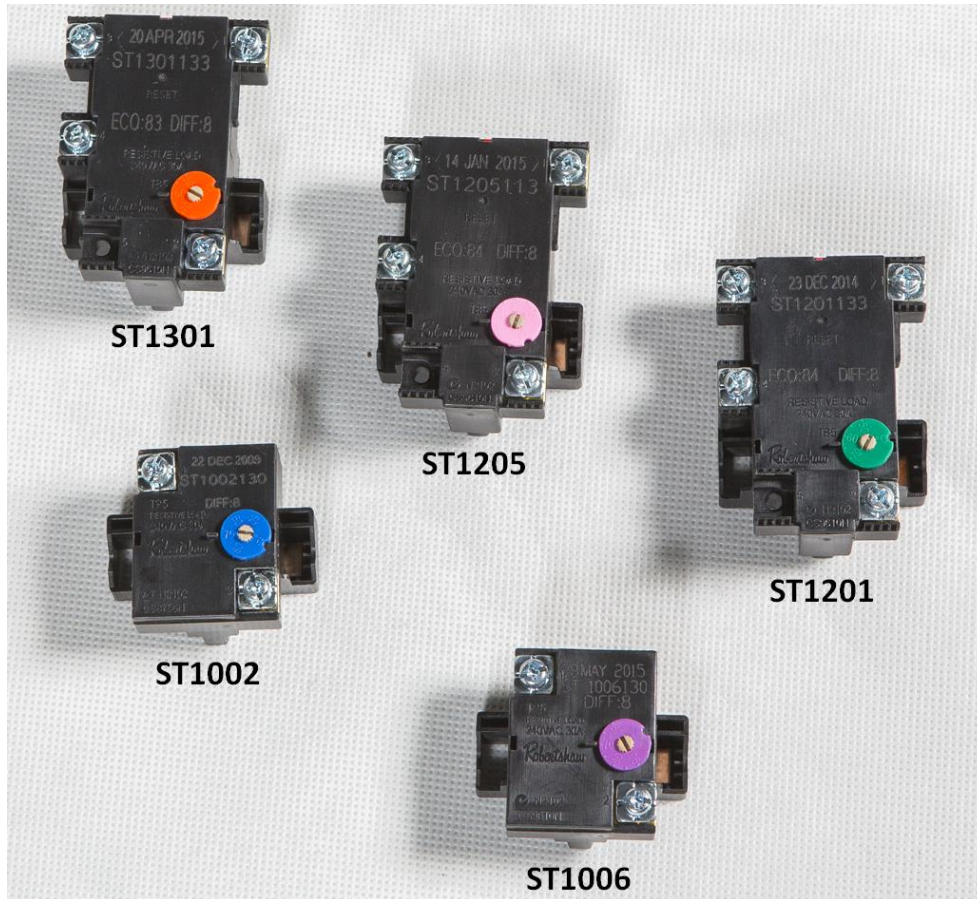

CODE	DESCRIPTION	DIAL COLOUR
ST1201	THERMOSTAT SURFACE 50-70C (BOTTOM)	DARK GREEN
ST1205	THERMOSTAT SURFACE 60-80C (BOTTOM)	PINK
ST2201	THERMOSTAT SURFACE 50-70C (TOP)	DARK GREEN
ST1301	THERMOSTAT SURFACE 50-80C (SOLAR)	RED
ST2207	THERMOSTAT SURFACE 60C FIXED	WHITE
ST1208	THERMOSTAT SURFACE 70C FIXED	DARK GREEN
ST1002	THERMOSTAT SURFACE 50-80C	DARK BLUE
ST1006	THERMOSTAT SURFACE 60-90C	PURPLE

Contact us for more information.

**Sales: 1800 333 191**  
**sales@stokesap.com.au**

# Stokes

## Appliance Parts

Domestic Commercial Industrial

## INDUSTRIAL HEATING SOLUTIONS



Formerly known as Stokes Synertec, the industrial division at Stokes Appliance Parts specialise in supplying heating solutions to Australian and international clients.

The experienced team can design and manufacture a vast range of tubular sheathed industrial heating elements and systems, and work with engineers to find practical solutions for specific applications.

Stokes Appliance Parts are the only authorised Australian CCI Thermal agent which includes their Explosion-Proof Caloritech immersion heaters and Ruffneck exhaust fans.

Some of our electrical heating solutions include; Water, oil, gas and air (finned or unfinned). Withdrawable, inline circulation and flanged units (including vessels). Plating. Load bank and air handling units.

**Download one of our catalogues at <https://industrial.stokesap.com.au>**

**Contact us for more information.**

**Sales: 1800 333 191**

**[industrial@stokesap.com.au](mailto:industrial@stokesap.com.au)**

## BEND IT YOURSELF STRAIGHT LENGTH ELEMENTS

LENGTH (+/- 10)

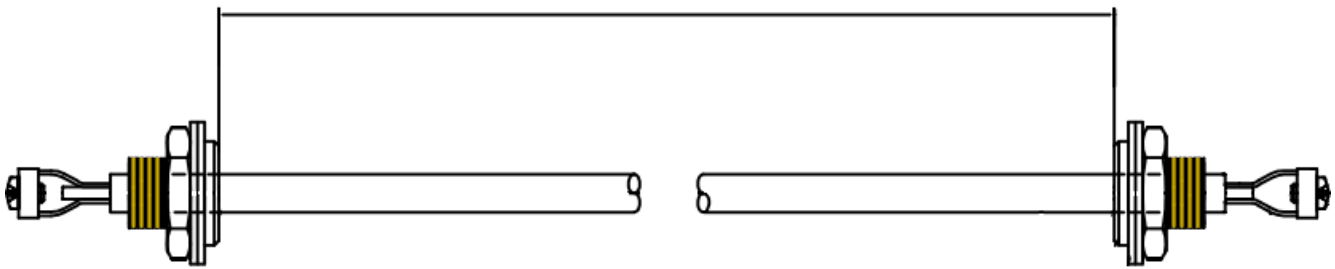

High density Range 46.5 kW/m <sup>2</sup> (30W/in <sup>2</sup> ) Suitable for wet Bain Marie applications and water immersion		
CODE	RATING	LENGTH
2201-10B	500W	455mm
2202-10B	750W	675mm
2203-10B	1000W	875mm
2204-10B	1250W	1095mm
2205-10B	1500W	1295mm
2206-10B	1800W	1555mm
2207-10B	2000W	1735mm
2208-10B	2500W	2155mm
2209-10B	3000W	2575mm

Low density Range 31kW/m <sup>2</sup> (20W/in <sup>2</sup> ) Suitable for wet or dry Bain Marie applications, water or oil immersion		
CODE	RATING	LENGTH
2211-10B	500W	675mm
2212-10B	750W	995mm
2213-10B	1000W	1295mm
2214-10B	1250W	1635mm
2215-10B	1500W	1935mm
2216-10B	1800W	2315mm
2217-10B	2000W	2575mm
2218-10B	2500W	3215mm

Straight length elements come complete with standard 3/8" BSP brass bushes fitted, gaskets and lock nuts.

Custom lengths, wattages, voltages or forms can be made on request.

**Please note:** elements over 1.2m in length may be coiled for transport purposes.

**Ask us about thermostats, knobs and other products for your Bain Marie application.  
Contact us for more information.**

**Sales: 1800 333 191**  
**sales@stokesap.com.au**

# Stokes

## Appliance Parts

Domestic Commercial Industrial

## 2" BSP TRIPLE IMMERSION ELEMENTS



### 31kW/m<sup>2</sup> (20W/in<sup>2</sup>) Range

*Suitable for water, oil or alkaline cleaning solutions.*

CODE	RATING	IMMERSION LENGTH
2620	1500W	364mm
2621	2400W	585mm
2622	3000W	680mm
2623	3750W	855mm
2624	4500W	997mm
2625	5400W	1190mm
2626	6000W	1320mm
2627	7500W	1640mm

### 77.5kW/m<sup>2</sup> (50W/in<sup>2</sup>) Range

*Suitable for water heating.*

CODE	RATING	IMMERSION LENGTH
2630	1800W	221mm
2631	2400W	297mm
2632	3600W	372mm
2633	4500W	447mm
2634	5400W	522mm
2635	6000W	574mm
2636	7200W	675mm
2637	9000W	827mm
2638	10.8KW	974mm
2639	14.4KW	1282mm

### 116kW/m<sup>2</sup> (75W/in<sup>2</sup>) Range

*Suitable for water heating.*

CODE	RATING	IMMERSION LENGTH
2640	1800W	144mm
2641	2400W	195mm
2642	3600W	246mm
2643	4500W	296mm
2644	5400W	346mm
2645	6000W	380mm
2646	7200W	448mm
2647	9000W	553mm
2648	10.8KW	643mm
2649	14.4KW	845mm

Stocked elements are rated for 240V (Can be wired for 3PH star connections)

All are manufactured with a double threaded 2" BSP brass boss, Incoloy 800 sheathed elements and a thermostat pocket. A fibre sealing gasket is supplied.

Optional metal red spun terminal covers (Code: 2620-34IND) and various built in thermostats can be supplied and fitted if required.

Custom wattage, voltage or lengths can be manufactured upon request.

**Contact us for more information.**

**Sales: 1800 333 191**

**industrial@stokesap.com.au**

# Stokes

## Appliance Parts

Domestic Commercial Industrial

### SCREW-IN WATER HEATERS

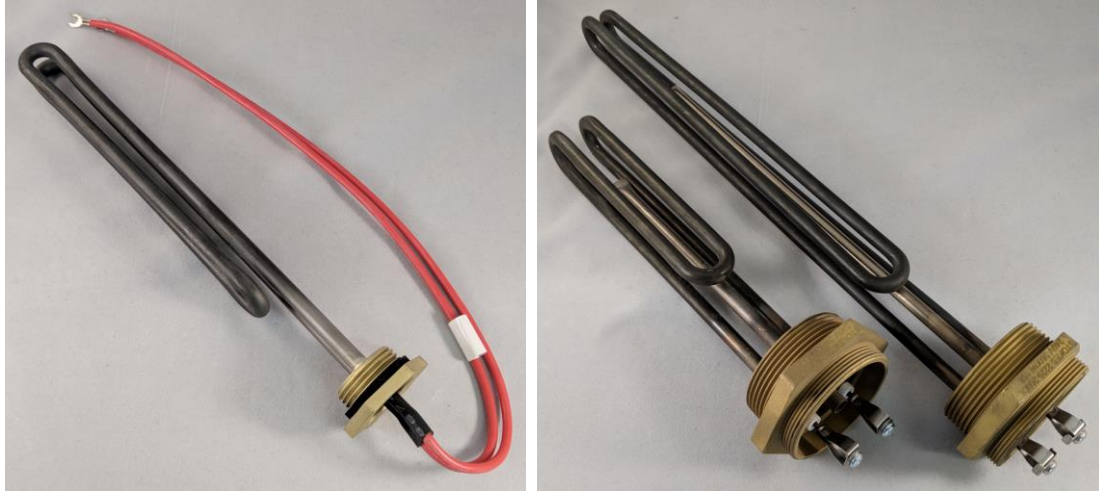

1" BSP		
CODE	RATING	IMMERSION
1325BL	1200W	170mm
1326BL	1500W	195mm
1327BL	1800W	220mm
1329BL	2400W	275mm
1330BL	3000W	315mm
1331BL	3600W	345mm
1333BL	4800W	405mm

1 1/4" BSP		
CODE	RATING	IMMERSION
2221-125	600W	150mm
2222-125	900W	200mm
2223-125	1200W	250mm
2224-125	1500W	180mm
2225-125	1800W	200mm
2226-125	2000W	220mm
2227-125	2400W	255mm
2228-125	3000W	305mm
2229-125	3600W	355mm
2230-125	4800W	455mm

2" BSP		
CODE	RATING	IMMERSION
2221-200	600W	145mm
2222-200	800W	200mm
2223-200	1200W	250mm
2224-200	1500W	180mm
2225-200	1800W	200mm
2226-200	2000W	220mm
2227-200	2400W	250mm
2228-200	3000W	300mm
2229-200	3600W	355mm
2230-200	4800W	455mm

Stocked elements are rated for 240V.

Lengths are +/- 10mm.

All are manufactured with a brass head using incoloy 800 sheathed elements.

1" BSP elements come with lead wires attached and sealing gasket supplied.

1 1/4" and 2" BSP elements have a thermostat pocket standard and sealing gasket supplied.

Metal spun terminal covers and brass locking nuts are available for 2" BSP only.

Custom wattage, voltage or lengths can be manufactured upon request.

**Contact us for more information.**

**Sales: 1800 333 191**

**sales@stokesap.com.au**

# Stokes

## Appliance Parts

Domestic Commercial Industrial

### RUN CAPACITORS



ROUND PLASTIC WITH BOLT	
CODE	RATING
CAP001	1 UF 450V
CAP002	2 UF 450V
CAP003	3 UF 450V
CAP004	4 UF 450V
2920600	4.5 UF 450V
CAP005	5 UF 450V
CAP006	6.3 UF 450V
CAP007	7 UF 450V
CAP008	8 UF 450V
CAP010	10 UF 450V
CAP012	12.5 UF 450V
CAP014	14 UF 450V
CAP016	16 UF 450V
CAP020	20 UF 450V
CAP025	25 UF 450V
CAP030	30 UF 450V
CAP035	35 UF 450V
CAP045	45 UF 450V
CAP060	60 UF 450V
CAP080	80 UF 450V

SQUARE PLASTIC	
CODE	RATING
2920700	1 UF 450V
2920701	2 UF 450V
2920702	2.5 UF 450V
2920703	3 UF 450V
2920704	3.5 UF 450V
2920705	4 UF 450V
2920706	4.5 UF 450V
2920707	5 UF 450V
2920708	5.5 UF 450V
2920709	7 UF 450V
2920710	9 UF 450V
2920711	11 UF 450V
2920712	12 UF 450V

ROUND METAL	
CODE	RATING
2920611	25 UF 450V
2920610	30 UF 450V
2920650	35 UF 450V
2920651	40 UF 450V
2920640	45 UF 450V
2920652	50 UF 450V
2920653	60 UF 450V

Our range of run capacitors are suitable for motors found in washing machines, dryers, air conditioning and other applications.

We also stock specific OEM replacement capacitors for various appliances.

**Contact us for more information.**

**Sales: 1800 333 191**

**sales@stokesap.com.au**



## STAINLESS STEEL FINNED ELEMENTS



46.5kW per sq. metre		
Min air flow of 1.0m/s req.		
CODE	RATING	DIM A
4061-U	600	230
4062-U	750	280
4063-U	1000	380
4064-U	1250	430
4065-U	1500	535
4066-U	1750	580
4067-U	2000	670
4068-U	2250	770
4069-U	2500	830
4070-U	2750	925
4071-U	3000	980
4072-U	3500	1165
4073-U	4000	1280
4074-U	4500	1470
4075-U	5000	1580

60.0kW per sq. metre		
Min air flow of 1.5m/s req.		
CODE	RATING	DIM A
4471-U	750	228
4472-U	1000	283
4473-U	1250	348
4474-U	1500	408
4475-U	1750	460
4476-U	2000	528
4477-U	2500	639
4478-U	3000	748
4479-U	3500	860
4480-U	4000	975
4481-U	4500	1110
4482-U	5000	1237
4483-U	6000	1455

93.0kW per sq. metre		
Min air flow of 2.8m/s req.		
CODE	RATING	DIM A
2321-U	1000	230
2322-U	1200	230
2323-U	1500	280
2324-U	2000	380
2325-U	2500	430
2326-U	3000	536
2327-U	3500	580
2328-U	4000	670
2329-U	5000	844
2305-U	6000	980

124.0kW per sq. metre		
Min air flow of 3.0m/s req.		
CODE	RATING	DIM A
2350-U	1000	200
2351-U	1500	230
2352-U	2000	282
2353-U	2500	330
2354-U	3000	400
2355-U	4000	530
2356-U	5000	670
2357-U	6000	801

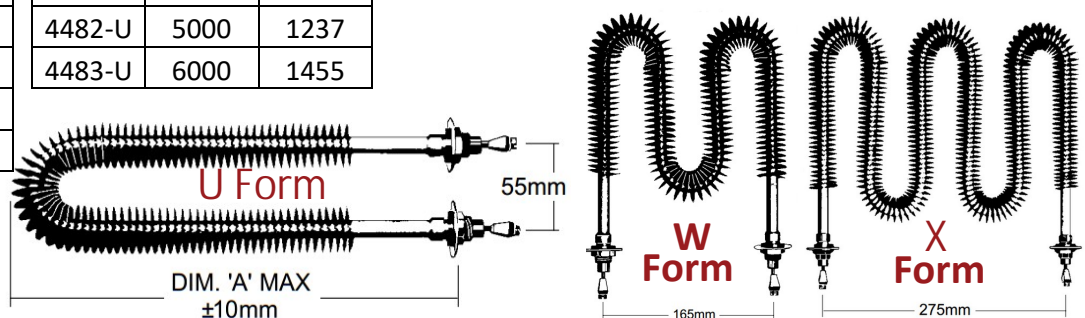

Rated quoted is wattage at 240V. Lengths above are for U form elements, contact us for W and X dim A. All elements are manufactured with stainless steel tube sheath and fins, fitted with 3/8" BSP brass bushes. Custom wattage, voltage or lengths can be manufactured upon request. Min order and lead times apply.

Download our air heating catalogue from our website – <https://industrial.stokesap.com.au>

Contact us for more information.

Sales: 1800 333 191

industrial@stokesap.com.au

# Stokes

## Appliance Parts

Domestic Commercial Industrial

## CHANNEL STRIP HEATERS

Channel strip heaters are designed to provide reliable uniform heat to flat surfaces suitable for drying cabinets, anti-condensation control and switch board cubicles, ovens, platens, incubators, moulds, sealing cabinets, autoclaves, air heating plus a variety of industrial and commercial heating applications.

CODE	WATTAGE	LENGTH
SH80203	80W	203MM 8IN
9700	150W	203MM 8IN
9701	250W	267MM 10.5IN
9703	500W	387MM 15.25IN
9704	500W	533MM 21IN
9705	750W	387MM 15.25IN
9706	750W	533MM 21IN
9708	1000W	533MM 21IN
9710	1000W	915MM 36IN
SH10001220	1000W	1220MM 48IN

\* All units are 240V

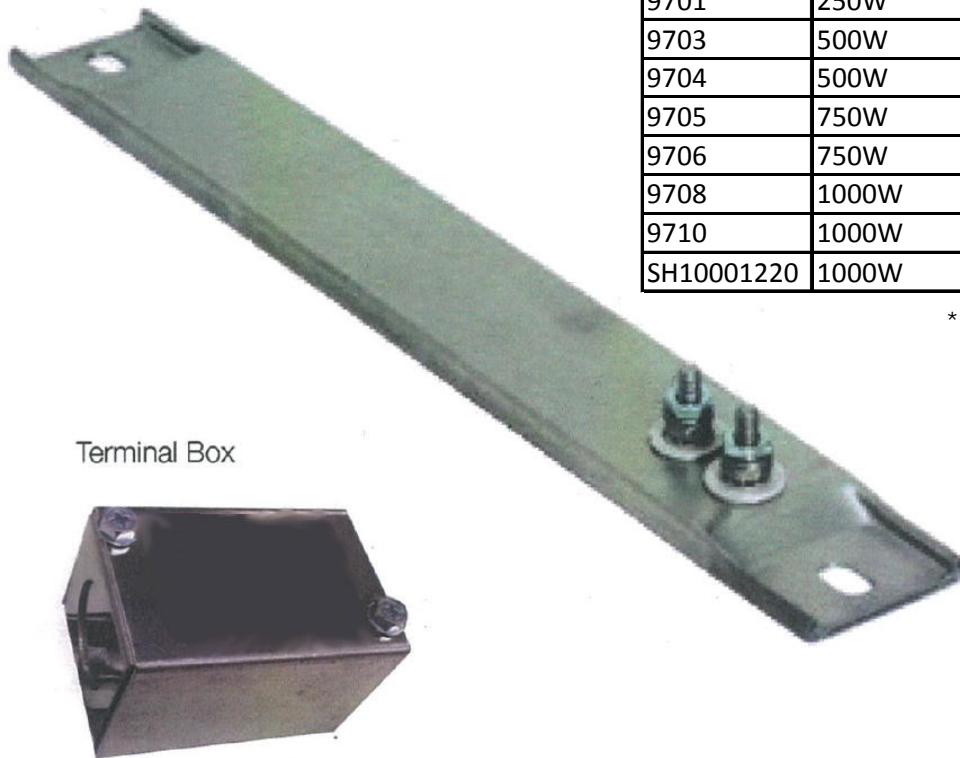

Terminal Box



Channel strip heaters come with Terminal boxes and slotted tabs.

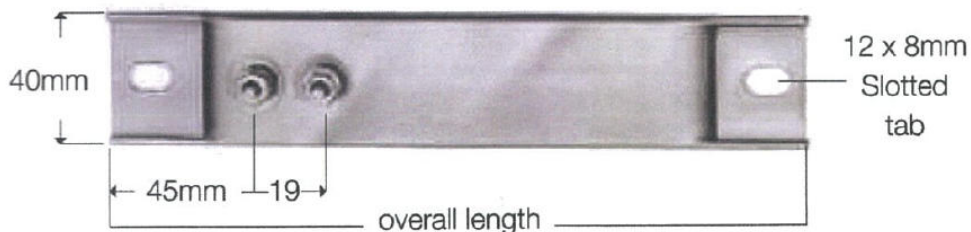

Contact us for more information.

Sales: 1800 333 191

[sales@stokesap.com.au](mailto:sales@stokesap.com.au)

STOKES CODE	DESCRIPTION	CROSS REFERENCE
10252	ELEMENT FAN FORCED 2400W - ILVE	TF6791R
10318	FAN FORCED OVEN ELEMENT 2200W	TF1260 / GA26A0
10343	FAN FORCED OVEN ELEMENT 2400W	TF1261 / GA260001
10676	F/F 2000W SMEG CENTRE HOLE MOUNT	IM21-07 / 806890807
10758	F/F OVEN 2200W SMEG WITH BOLTS	IM21-01
10759	2300W F/F ELEMENT SMEG X3 RING	IM101-01
10759A	2700W F/F ELEMENT SMEG 3 RING NO EARTH	IM21-05
1976	OVEN ELEMENT 2400W - CHEF FAN FORCED	TF6791 / 56331
203174	OVEN F/F 2400W SMEG BLANCO AEG OMEGA FRA	IM51-02
2546	OVEN ELEMENT (F/F) 2200W - SUITS DE07	TF2500 / VG2500
2550	OVEN ELEMENT (FAN FORCED) 1800W	TF9401 / FN94B001
9666	ELEMENT OVEN FF 2500W BLANCO GLEM MIELE	IM11-01
ARISC00141180	2800W F/F LONG NECK ELEMENT	IM61-03
ERM170	2200W F/F ELEMENT ELECTROLUX LATEST MODE	TF3505
ERM686	ELEMENT F/F 2200W	TF167
ERM696	FAN FORCED ELEMENT 230V 2500W X3 RING	TF2325
EU010	EUROMAID F/F 1800W 200MM 1505T1	IM91-10
FP447752	ELEMENT ASSY F/F F&P & NEFF 2500W	TF2947 / 20.29477.020
GN379201	ELEMENT FAN 2200W	IM81-03
ME12570030	ELEMENT FAN 2300W 230V	12570030
10319	GRILL ELEMENT 2200W	TG1820
10323	OVEN ELEMENT 2000W	TO1830
11656	ELEMENT C/HEAT 1800W S/S321	TO8701 / 0122004537
1893	OVEN ELEMENT 2400W	TO3981 / QJ0300
9613	OVEN ELEMENT 1800W	TO1601 / VF61D0
10540	TOP OVEN ELE 1300 SHORT PLATE TECHNIKA	IM12-03 / 20.40391.000
10540L	TOP OVEN ELE 1300W LONG PLATE TECHNIKA	IM12-01
ERM679	GRILL ELEMENT 2200W 345MM X 380MM	20.35146.000
GC566-1170	ELEMENT BTM 1300 W GLEM TECHNIKA	IM12-02
ERM666	FAN MOTOR TWIST MOUNT	9683G / 0214002118K
9683	MOTOR FAN FORCED OVEN WITH BLADE&NUT	2079
55.13022.050	THERMOSTAT 30-110 DEG C	EF55.13022.050
7400-E	THERMOSTAT CAPELLARY 30-110 DEG-EGO TYPE	55.18224.010
9780	THERMOSTAT 50-320C 16 AMP	55.17063.040
EFG-201	OVEN THERMOSTAT 50-300C 16AMP	EFG-201
ERM056	SEAL MAIN OVEN 1675MM	188002236
ERM510	TIMER 2HR CUT OFF PEAPSA	609100270
ED300876	SELECTOR SWITCH	33301001
ERM263	6MM NEON INDICATOR W/LENS	TS269 / 0609100269

Contact us for more information.

**Sales: 1800 333 191      sales@stokesap.com.au**

Stokes Appliances Pty Ltd Unit 2, 170 Rooks Road, Nunawading VIC 3131 PO Box 168 Mitcham Victoria 3132

T +61 3 9872 7474 F +61 3 9872 7444 www.stokesap.com.au

STOKES CODE	DESCRIPTION	CROSS REFERENCE
1801-10	HOTPLATE 8 ELEMENT 2100W	TH1720
1803-10	HOTPLATE 6 1/4 ELEMENT 1250W	TH1710
1888	HOTPLATE SOLID 145MM 1500W GLEM	HP-145R-4
1889	HOTPLATE SOLID 180MM 2000W GLEM	HP-180R-4
2431	HOTPLATE 8 ELEMENT 2100W WIRED IN	TH1338 / 4800338
2433	HOTPLATE 6 1/4 ELEMENT 1250W WIRED IN	TH1334 / 4800334
9523	HOTPLATE 145MM 1100W INC. TRIM RING	TH1100 / FV10A0
9525	HOTPLATE 180MM 1800W INC. TRIM RING	TH1800 / FV11A0
9560	H/PLATE 6 INCH 1250W -75C804W	TH800C / GB80C0
9561	HOT PLATE 8 INCH 2050W - 75C804W	TH820C / GB82C0
9791	H/PLATE CERAMIC 165MM 1200W CERAMASPEED	10.54111.042 / 374063522
9817	CERAN HOTPLATE 200MM 1800W	10.58111.043 / 374063622
ERM302	ELEMENT CERAM MAGMA 215MM DIA 2000W	10.59111.042
1255-42	TRIM RING 8 INCH	TR2800
1256-07	TRIM RING 6 1/4 INCH	TR2799
10553	INFINITE CONTROL 13A	50.56078.008
7405	INFINITE CONTROL 13A	50.56078.007 / TS0002
M553-14	INFINITE CONTROL 15A	TM55314
M583-14	INFINITE CONTROL 15A	TM58314
M823-14	INFINITE DIVIDED CONTROL 15A	TM82314
MD3-110K	ENERGY REGULATOR DIVIDED 15A	TMD3-110
MP-101	ENERGY REGULATOR SPSC WITH PILOT	MP101
AH6006	PANTRY SWITCH SPST 10 A	6006
ERM095	SWITCH ROCKER WHITE ROUNDED CORNERS	1300.25.09
7021C	SWITCH TOGGLE DPST 20A 250V ON-OFF	7021C
T4060B	THERMOSTAT ROOM S.P.S.T. 240V	T4360G1006
T6060B	THERMOSTAT ROOM S.P.D.T. 240V	T6360E1005
UNI102	GLOBE OVEN/M'WAVE 25W 300 C SES E14	AI00232108
9415	INFR QTZ LAMP 232M 500W CERAMIC NO LEADS	64245028
9418	INFRARED QUARTZ LAMP 200W 240V 118MM LON	64242013
9418A	INFRARED QUARTZ LAMP 300W 240V 118MM	64243011
9417	INFRARED QUARTZ LAMP 500W 240V 220MM	64245014
ROBEC0046	LAMP 1000W HALOGEN 189MM	EC0046
9338	QUARTZ I R 100 w R7S 118mm C J LAMP	64241017
ROBEC0422	QUARTZ I RED LAMP 250W 180MM	EC0422
ROBES0255	QUARTZ LAMP 250W 300 MM O/ALL METAL TAGS	ES0255
ROBES0256	QUARTZ LAMP 350W 300MM METAL TAGS	ES0256

Contact us for more information.

**Sales: 1800 333 191      [sales@stokesap.com.au](mailto:sales@stokesap.com.au)**

Stokes Appliances Pty Ltd Unit 2, 170 Rooks Road, Nunawading VIC 3131 PO Box 168 Mitcham Victoria 3132

T +61 3 9872 7474 F +61 3 9872 7444 [www.stokesap.com.au](http://www.stokesap.com.au)

